

# ÇELİKLER

ALÜMİNYUM PLASTİK SAN. VE TİC. A.Ş.

## HALI BASAMAK VE LAMİNAT PARKE PROFİLLERİ

web: [www.celikleraluminyum.com.tr](http://www.celikleraluminyum.com.tr)  
email: [celikler@celikleraluminyum.com.tr](mailto:celikler@celikleraluminyum.com.tr)



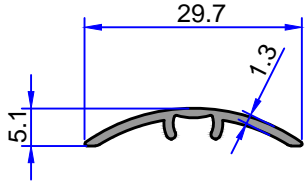

**9427**  
0.121 kg/m

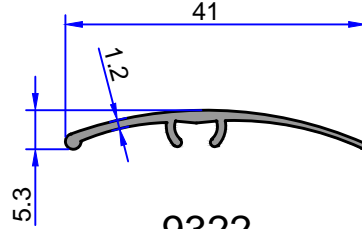

**9322**  
0.156 kg/m

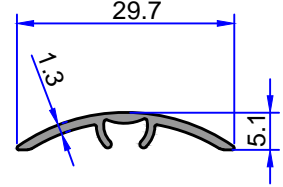

**10536**  
0.124 kg/m

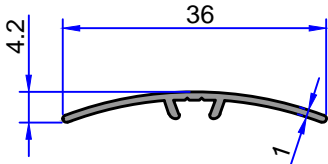

**5191**  
0.117 kg/m

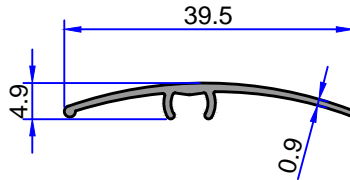

**10108**  
0.138 kg/m

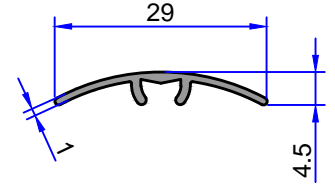

**5381**  
0.107 kg/m

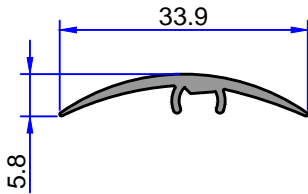

**4721**  
0.154 kg/m

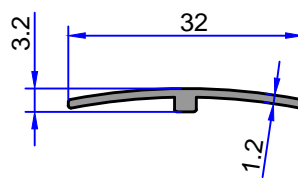

**5267**  
0.120 kg/m

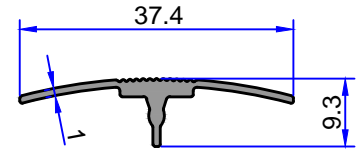

**6124**  
0.168 kg/m

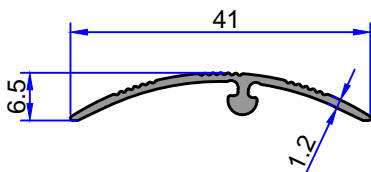

**10-2722**  
0.157 kg/m

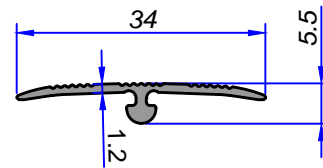

**10-2723**  
0.127 kg/m

Not: Katalog ağırlıkları teorik ağırlıklardır. Üzerine kalıp aşınmasından dolayı %3-%5 boya farkından dolayı %4-%6 ağırlık ilave edilecektir.

# HALI BASAMAK VE LAMİNAT PARKE PROFİLLERİ

**ÇELİKLER**  
ALÜMİNYUM PLASTİK  
SAN.VE TİC. A.Ş.

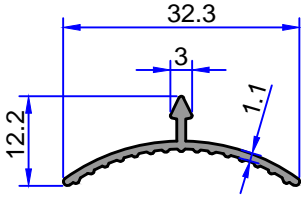

**5305**  
0.137 kg/m

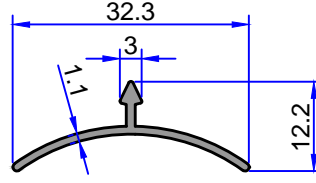

**5306**  
0.127 kg/m

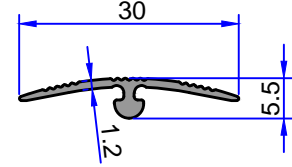

**10-2716**  
0.114 kg/m

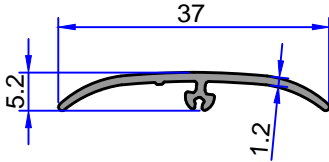

**9929**  
0.147 kg/m

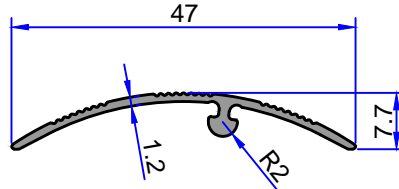

**10-2721**  
0.176 kg/m

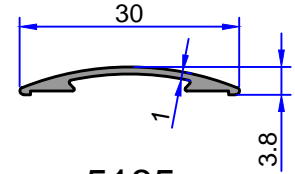

**5185**  
0.105 kg/m

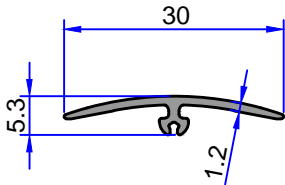

**4999**  
0.116 kg/m

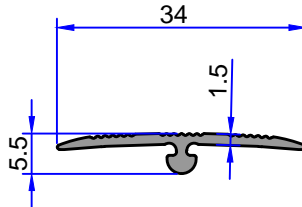

**10-2710**  
0.148 kg/m

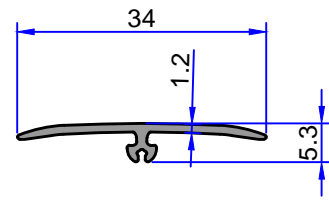

**5000**  
0.130 kg/m

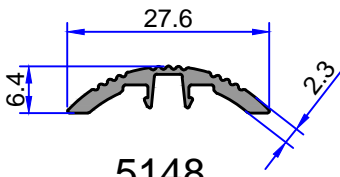

**5148**  
0.157 kg/m

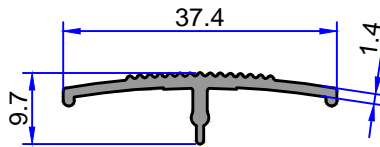

**5088**  
0.207 kg/m

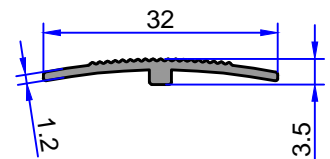

**5089**  
0.128 kg/m

Not: Katalog ağırlıkları teorik ağırlıklardır. Üzerine kalıp aşınmasından dolayı %3-%5 boya farkından dolayı %4-%6 ağırlık ilave edilecektir.

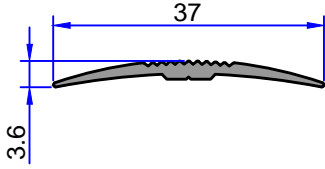

**6505**  
0.147 kg/m

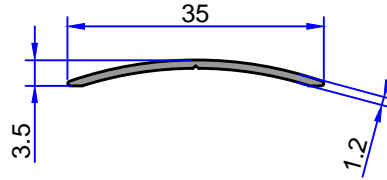

**5400**  
0.106 kg/m

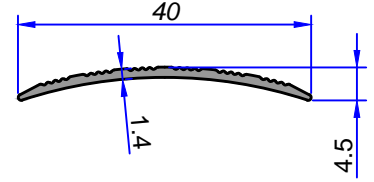

**10-2702**  
0.138 kg/m

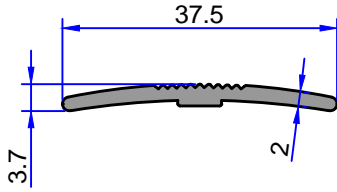

**5284**  
0.215 kg/m

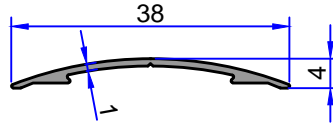

**9806**  
0.111 kg/m

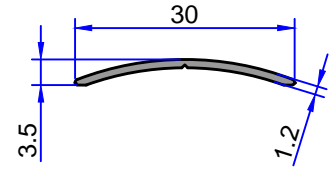

**5181**  
0.092 kg/m

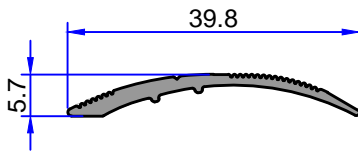

**10167**  
0.190 kg/m

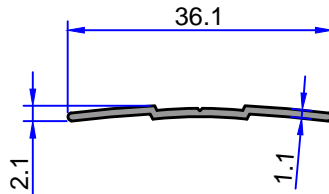

**5433**  
0.109 kg/m

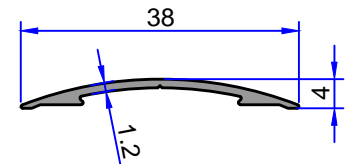

**5184**  
0.132 kg/m

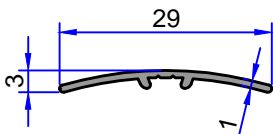

**5530**  
0.087 kg/m

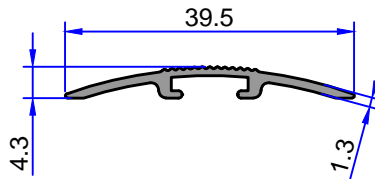

**5104**  
0.160 kg/m

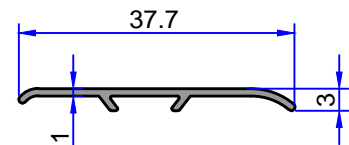

**1706**  
0.117 kg/m

# HALI BASAMAK VE LAMİNAT PARKE PROFİLLERİ

ÇELİKLER  
ALÜMİNYUM PLASTİK  
SAN.VE TİC. A.Ş.

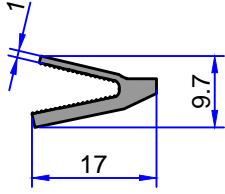

**3877**  
0.135 kg/m

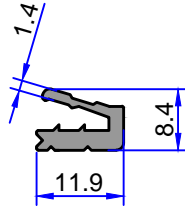

**3928**  
0.133 kg/m

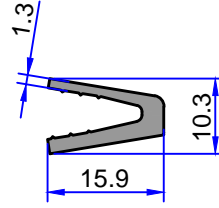

**3876**  
0.169 kg/m

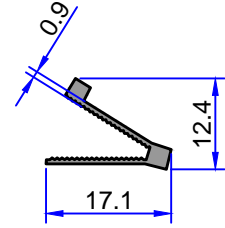

**3852**  
0.089 kg/m

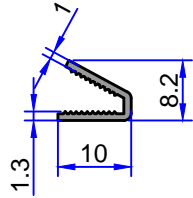

**3853**  
0.043 kg/m

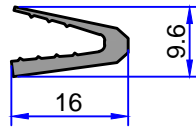

**3875**  
0.134 kg/m

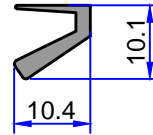

**3866**  
0.100 kg/m

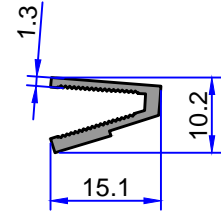

**3867**  
0.120 kg/m

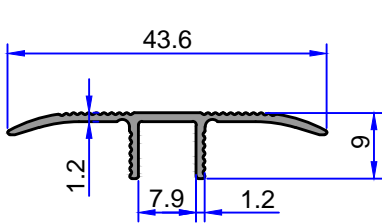

**10-2715**  
0.175 kg/m

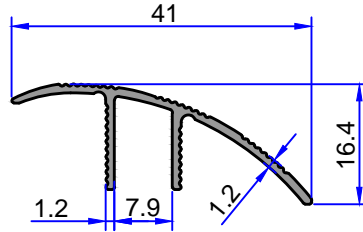

**10-2714**  
0.202 kg/m

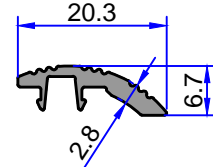

**5149**  
0.134 kg/m

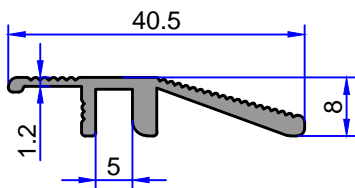

**5282**  
0.286 kg/m

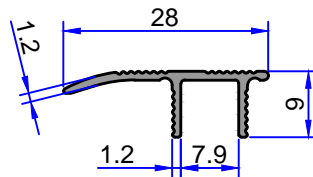

**10-2713**  
0.127 kg/m

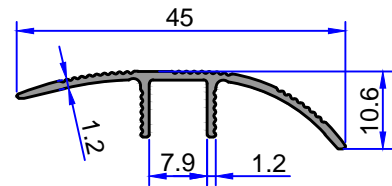

**10-2712**  
0.186 kg/m

Not: Katalog ağırlıkları teorik ağırlıklardır. Üzerine kalıp aşınmasından dolayı %3-%5 boya farkından dolayı %4-%6 ağırlık ilave edilecektir.

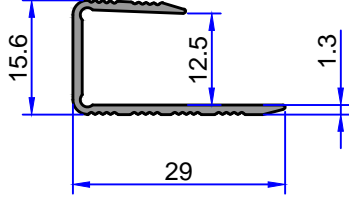

**10-2726**  
0.177 kg/m

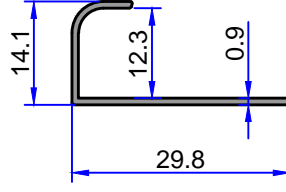

**6125**  
0.118 kg/m

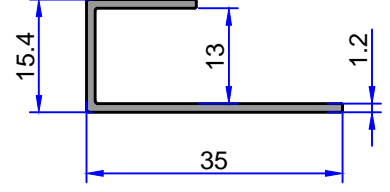

**7351**  
0.204 kg/m

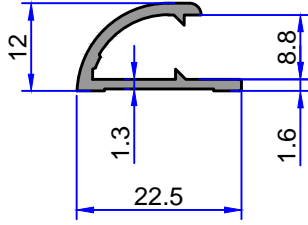

**3883**  
0.181 kg/m

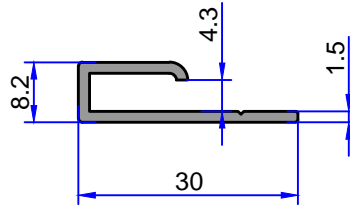

**4983**  
0.203 kg/m

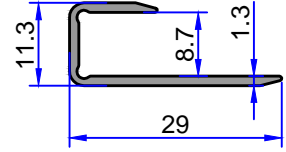

**4712**  
0.160 kg/m

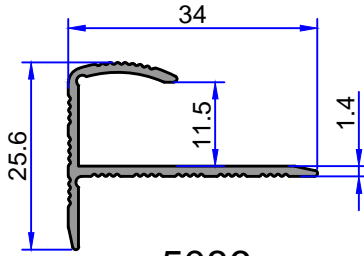

**5086**  
0.240 kg/m

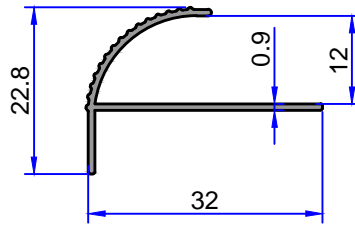

**6126**  
0.160 kg/m

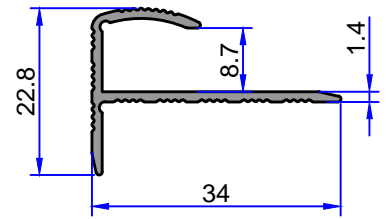

**10-2708**  
0.230 kg/m

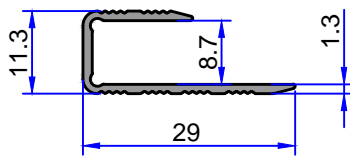

**10-2707**  
0.161 kg/m

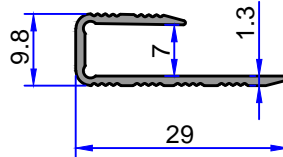

**10-2703**  
0.156 kg/m

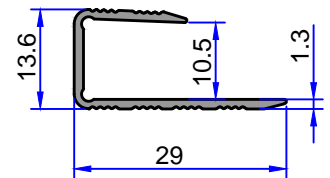

**10-2724**  
0.170 kg/m

# HALI BASAMAK VE LAMİNAT PARKE PROFİLLERİ

**ÇELİKLER**  
ALÜMİNYUM PLASTİK  
SAN.VE TİC. A.Ş.

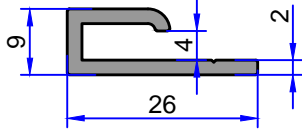

**5559**  
0.244 kg/m

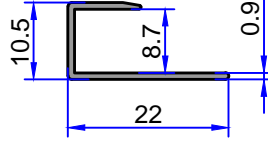

**5285**  
0.097 kg/m

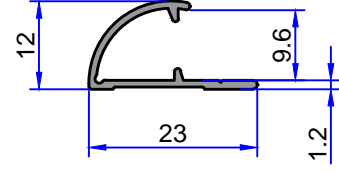

**5595**  
0.122 kg/m

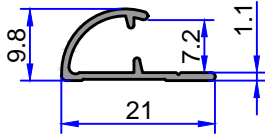

**5575**  
0.107 kg/m

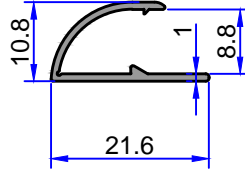

**5320**  
0.115 kg/m

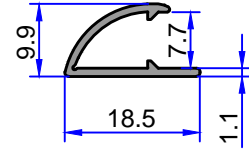

**5321**  
0.110 kg/m

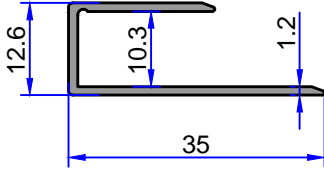

**9007**  
0.204 kg/m

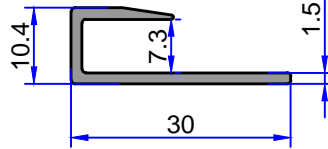

**6428**  
0.201 kg/m

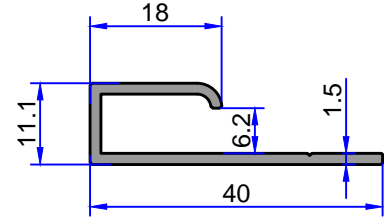

**11027**  
0.271 kg/m

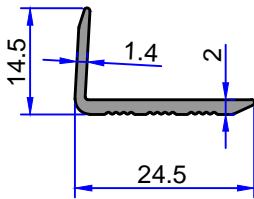

**10-2736**  
0.164 kg/m

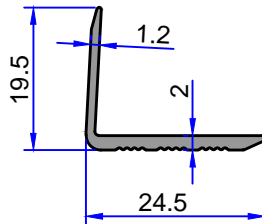

**10-2709**  
0.174 kg/m

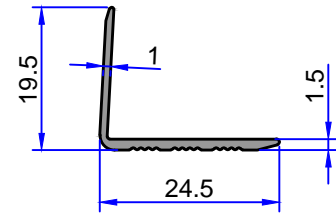

**10-2718**  
0.136 kg/m

Not: Katalog ağırlıkları teorik ağırlıklardır. Üzerine kalıp aşınmasından dolayı %3-%5 boya farkından dolayı %4-%6 ağırlık ilave edilecektir.



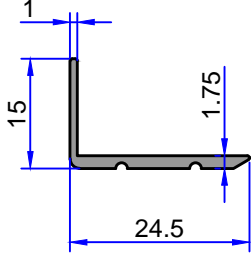

**5085**  
0.142 kg/m

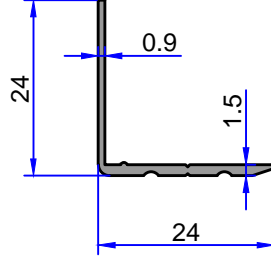

**5188**  
0.143 kg/m

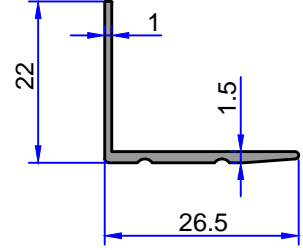

**4995**  
0.153 kg/m

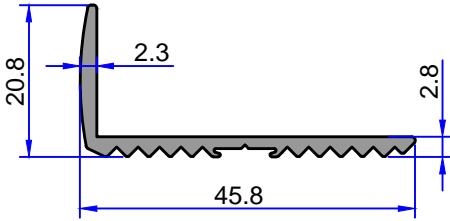

**5087**  
0.344 kg/m

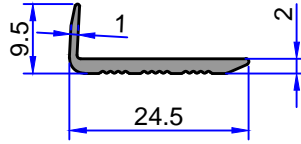

**10-2704**  
0.138 kg/m

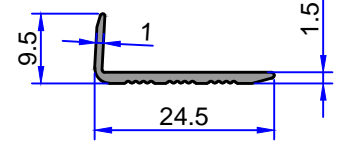

**10-2717**  
0.109 kg/m

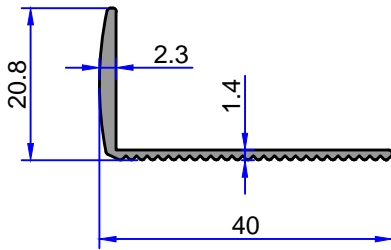

**5268**  
0.224 kg/m

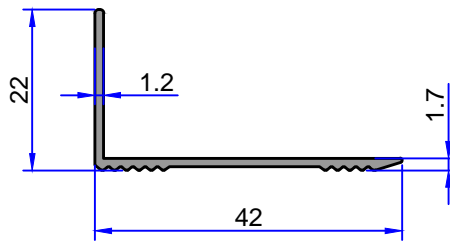

**5192**  
0.209 kg/m

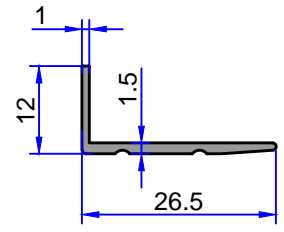

**4996**  
0.126 kg/m

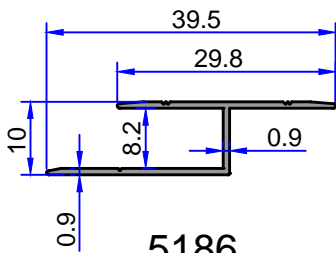

**5186**  
0.148 kg/m

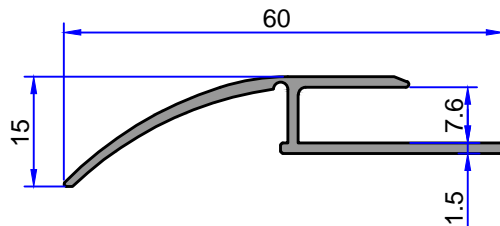

**5888**  
0.347 kg/m

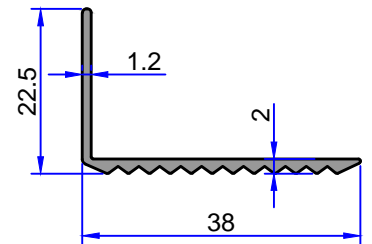

**9068**  
0.218 kg/m

# HALI BASAMAK VE LAMİNAT PARKE PROFİLLERİ

**ÇELİKLER**  
ALÜMİNYUM PLASTİK  
SAN.VE TİC. A.Ş.

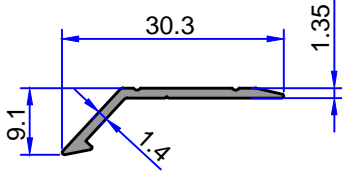

**5216**  
0.119 kg/m

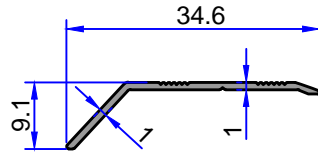

**6324**  
0.097 kg/m

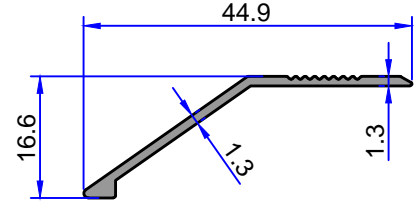

**5193**  
0.177 kg/m

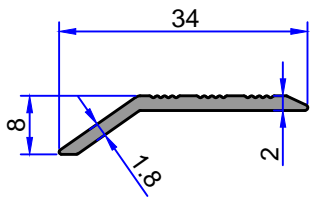

**10-2734**  
0.173 kg/m

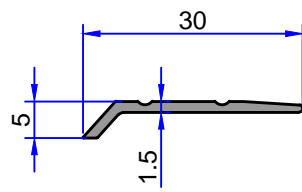

**4997**  
0.116 kg/m

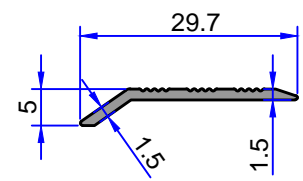

**10-2719**  
0.113 kg/m

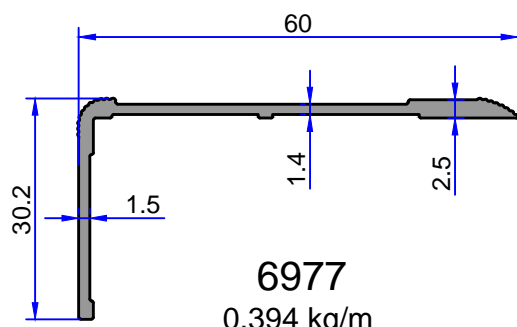

**6977**  
0.394 kg/m

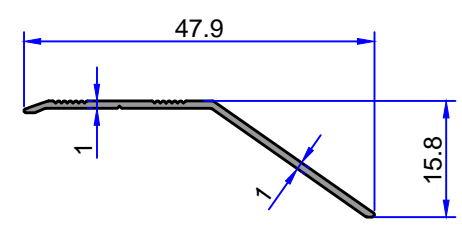

**6323**  
0.137 kg/m

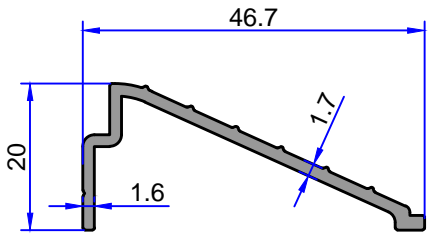

**11163**  
0.321 kg/m

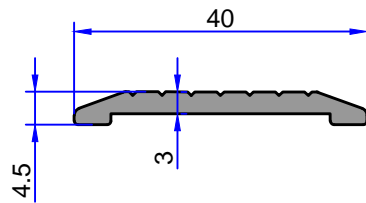

**4201**  
0.312 kg/m

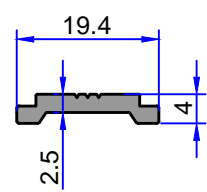

**4113**  
0.136 kg/m

Not: Katalog ağırlıkları teorik ağırlıklardır. Üzerine kalıp aşınmasından dolayı %3-%5 boya farkından dolayı %4-%6 ağırlık ilave edilecektir.



**HALI BASAMAK VE LAMİNAT  
PARKE PROFİLLERİ**

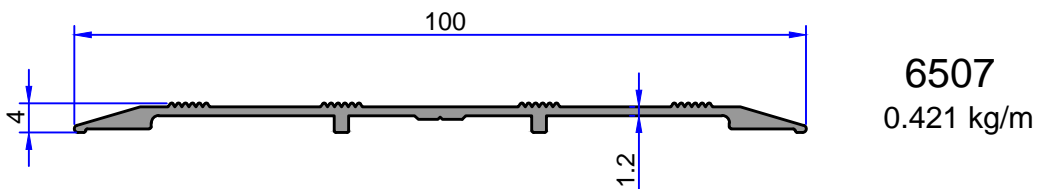
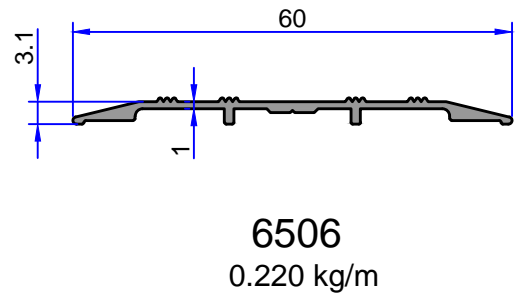
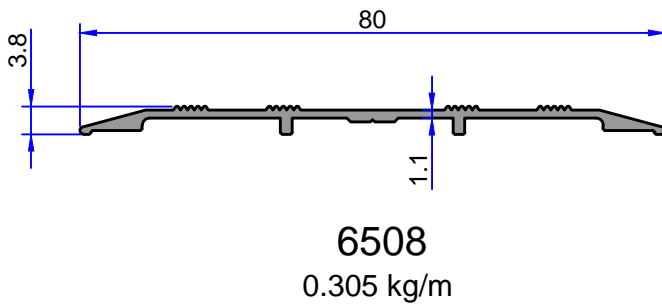
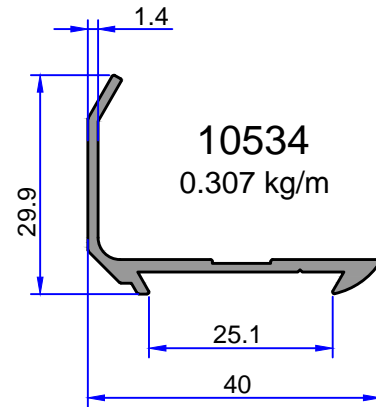
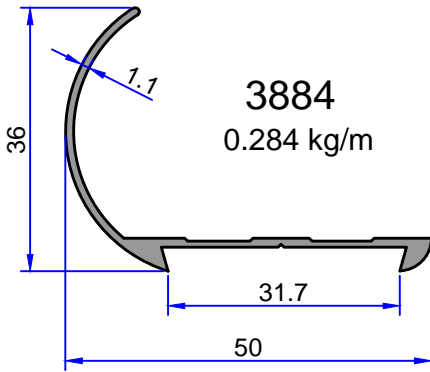
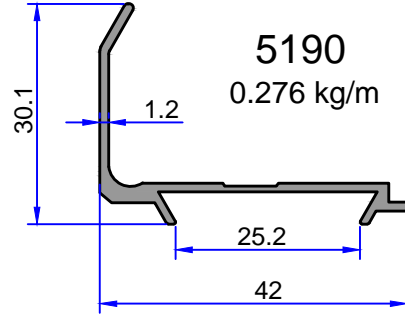
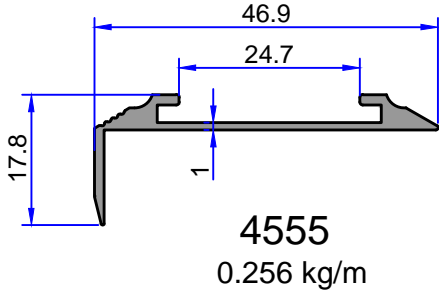

Not: Katalog ağırlıkları teorik ağırlıklardır. Üzerine kalıp aşınmasından dolayı %3-%5 boya farkından dolayı %4-%6 ağırlık ilave edilecektir.

# HALI BASAMAK VE LAMİNAT PARKE PROFİLLERİ

**ÇELİKLER**  
ALÜMİNYUM PLASTİK  
SAN.VE TİC. A.Ş.

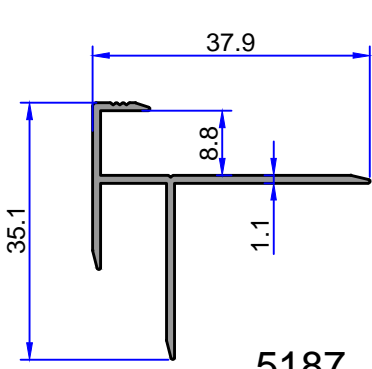

**5187**  
0.259 kg/m

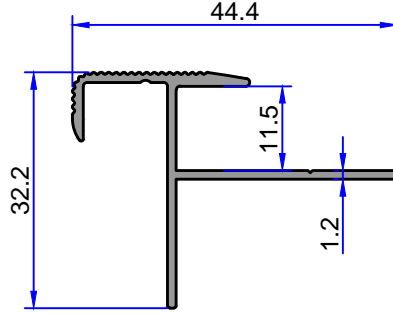

**5090**  
0.312 kg/m

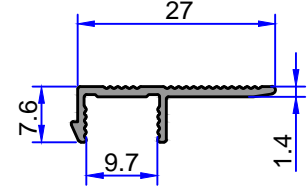

**10-2730**  
0.127 kg/m

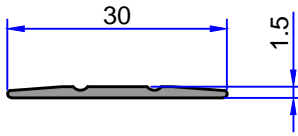

**4998**  
0.106 kg/m

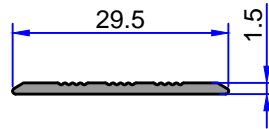

**10-2720**  
0.111 kg/m

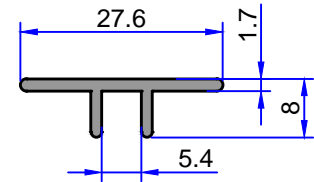

**3235**  
0.173 kg/m

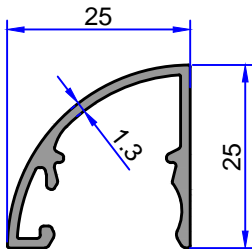

**10448**  
0.291 kg/m

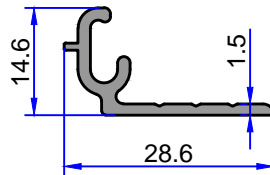

**10919**  
0.199 kg/m

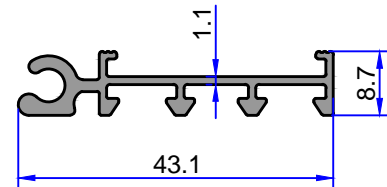

**10920**  
0.312 kg/m

Not: Katalog ağırlıkları teorik ağırlıklardır. Üzerine kalıp aşınmasından dolayı %3-%5 boya farkından dolayı %4-%6 ağırlık ilave edilecektir.

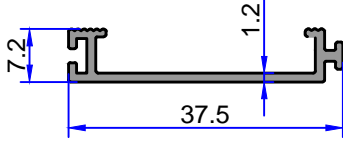

**10986**  
0.194 kg/m

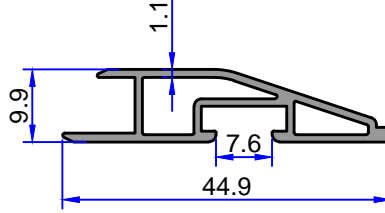

**10987**  
0.313 kg/m

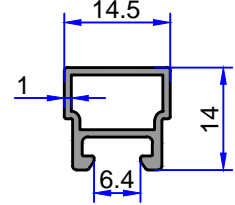

**11051**  
0.163 kg/m

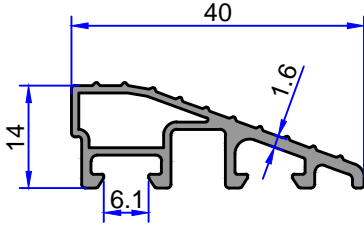

**11050**  
0.351 kg/m

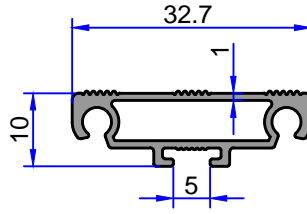

**5380**  
0.272 kg/m

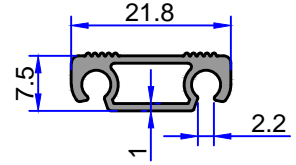

**5379**  
0.190 kg/m

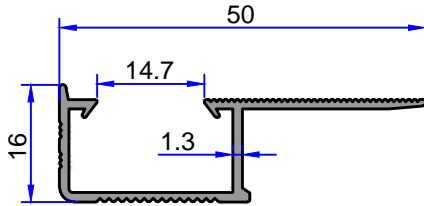

**5169**  
0.279 kg/m

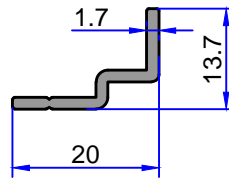

**11162**  
0.137 kg/m

